

**SUPPORT LOAD DIAGRAM-
POST MOUNTED**

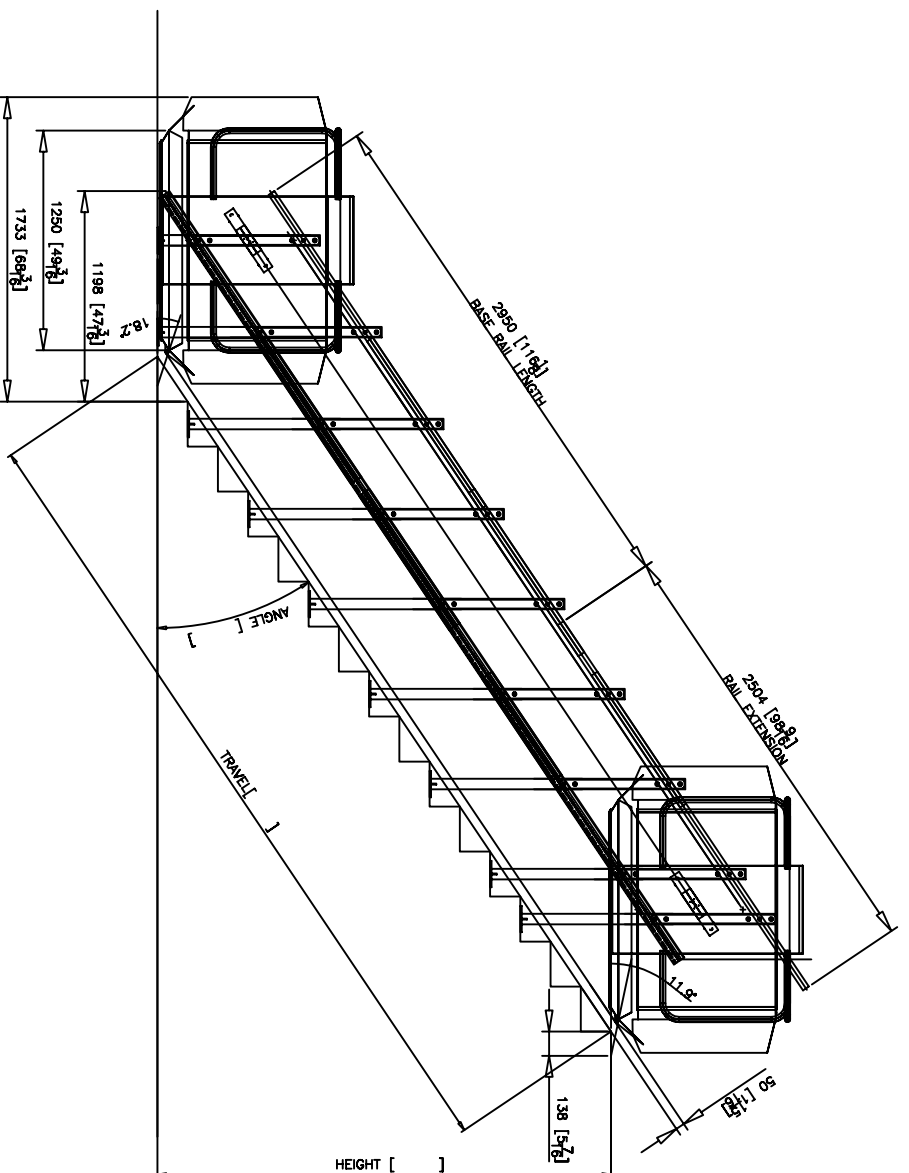

WALL MOUNTED

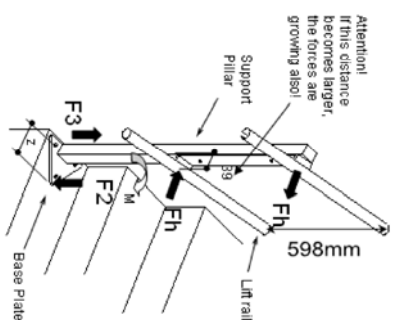

| | | | |
|---------------|-------|---------|---------|
| PILLAR FORCES | Z | F2 | F3 |
| BASE PLATE | 150mm | 16875 N | 11098 N |

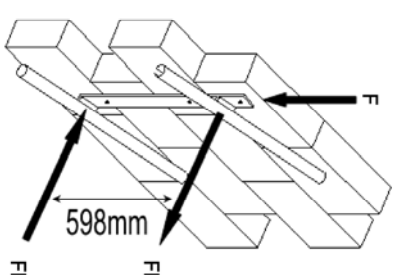

| |
|----------------------------|
| F = 5777 N (1300 lbf) |
| Fh = 4218.8 N (948.43 lb.) |

POST MOUNTED

WOODEN TREAD:
EACH POST MUST BE FIXED BY THROUGH BOLTS AT EVERY HOLES AND REINFORCED PLATE LOCATED UNDER THE TREAD.

REINFORCED CONCRETE:
SLEEVE ANCHORS 1/2-3.0" (EVERY HOLES) MAX. TORQUE: 28 Ft-Lbs. MIN. EMBEDMENT DEPTH: 2-1/4" 3000 PSI CONCRETE FLOOR MIN. REQ'D

WALL MOUNTED

WOODEN TREAD:
LAG BOLT HEX ϕ 1/2 X 5" MIN. EMBEDMENT DEPTH: 3" INTO THE WOOD PREDRILL WOOD ϕ 1/8" - MINIMUM OF 2 EVERY 16" THROUGH TOP METAL RAIL

REINFORCED CONCRETE:
SLEEVE ANCHORS 1/2-3.0" @ 20" C/C MAX. TORQUE: 28 Ft-Lbs. MIN. EMBEDMENT DEPTH: 1-5/8" 3000 PSI CONCRETE WALL MIN. REQ'D MINIMUM OF 1 EVERY 20" THROUGH TOP METAL RAIL

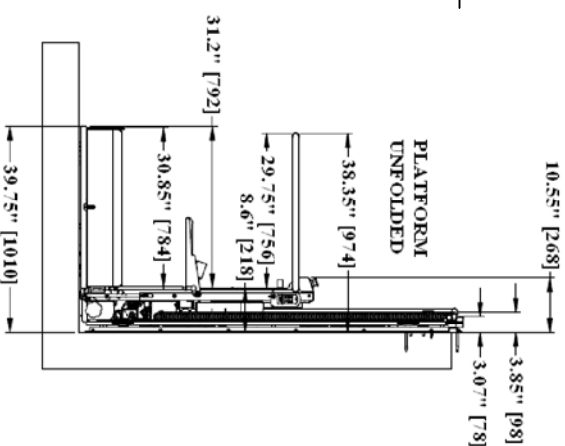
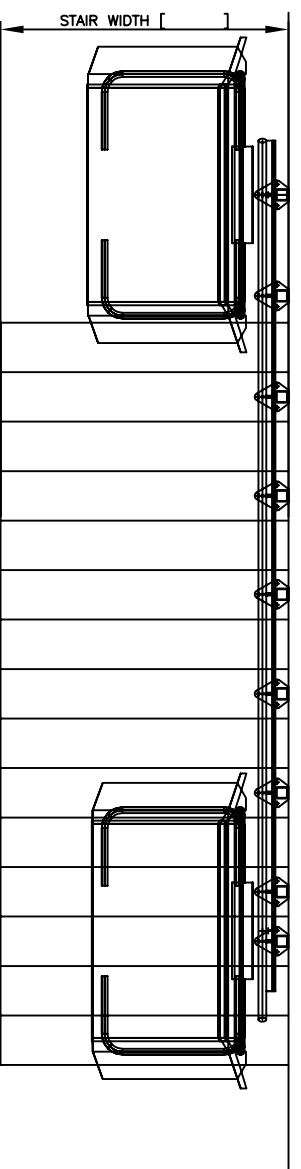

INLINE ACCESS PLATFORM
775 X 1250

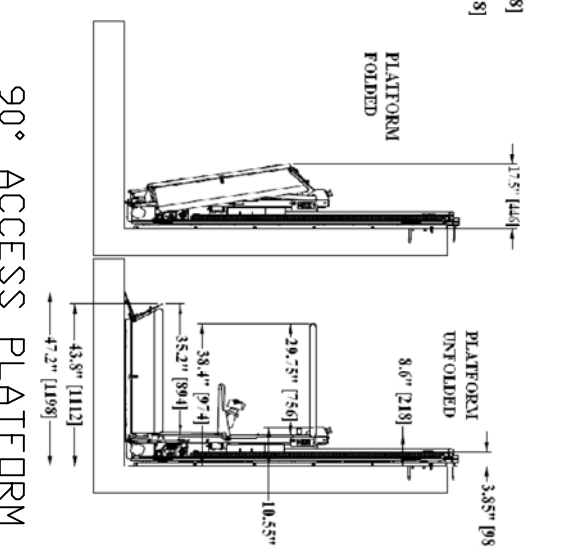

90° ACCESS PLATFORM
775 X 1250

NOTE:

- POST ADD 2.5" [63.5 mm]

SPECIFICATIONS

GENERAL

CLASSIFICATION: UNENCLOSED STAIRPLATFORM LIFT
APPLIED CODE: ASME A18.1: Sec. 6 (Priv.) / Section 3 (Pub.) CSA B355 09
MODEL: DELTA
CAPACITY: 550 Lbs (250 kg)
ONE PERSON IN WHEELCHAIR

SPEED: 20 ft/min [0.1 m/s]
PLATFORM SIZE: 720x900 (28.35x35.43) - 775x1250 (30.5x49.2)
POWER SUPPLY: 110V,15A,60Hz,SINGLE PHASEPOWER UNIT

MOTOR: 24 VDC, 0.67 HP
DRIVE SYSTEM: RACK AND PINION
CONTROLLER

MODEL: DELTA
TYPE: CPFS
ETL #: 94307

PROJECT INFORMATION

ACCESS TO PLATFORM:
SIDE OF INSTALLATION:
ANGLE OF STAIRCASE:
WIDTH OF STAIRCASE:
LENGTH OF STAIRWAY:
NUMBER OF RAIL:
NUMBER OF RISERS:
AVERAGE RISER:
AVERAGE TREAD:
LOCATION:

IN LINE / SIDE ACCESS
LEFT / RIGHT
X°
X°
X°
1
X°
X°
X°
INDOOR / OUTDOOR
WOOD/CONCRETE/N/A
WOOD/CONCRETE/N/A
RESIDENTIAL / PUBLIC

OPTIONS AVAILABLE:

ADDITIONAL BATTERY PACK;
SELF SUPPORT STAIR POST;
POST FOR CALL STATION;
ARM & MOTORIZED FOLDING PF;
FOLDING SEAT W/BELT;
INTERNATIONAL PACKAGE;
COLOR:

RAL 7035, LIGHTEST GREY

| | | |
|--------------------|---------------|---------------|
| ENTRANCE SIDE | LANDING 1 | LANDING 2 |
| CALL STN. MOUNTING | Surface Mount | Surface Mount |
| ENTRANCE LOCATIONS | | |

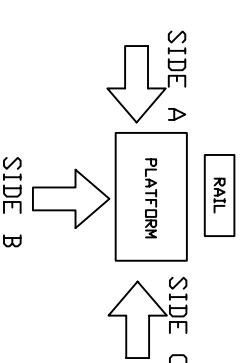

4 York Avenue
West Caldwell, NJ 07006
Tel: (973) 618-9545 Fax: (973) 618-9638

DATA SHEET

PROJECT:
ADDRESS:

CUSTOMER:

DATE: 09/13/2011

REVISION DATE:

COMPLETED BY: BISRAM

JOB No. 1

Part No. DELTA

Variant No.



SHEET No. 1 OF 1