

SECTIONAL VIEW

PROLIFT VOYAGER Model 3560WS (Gated)

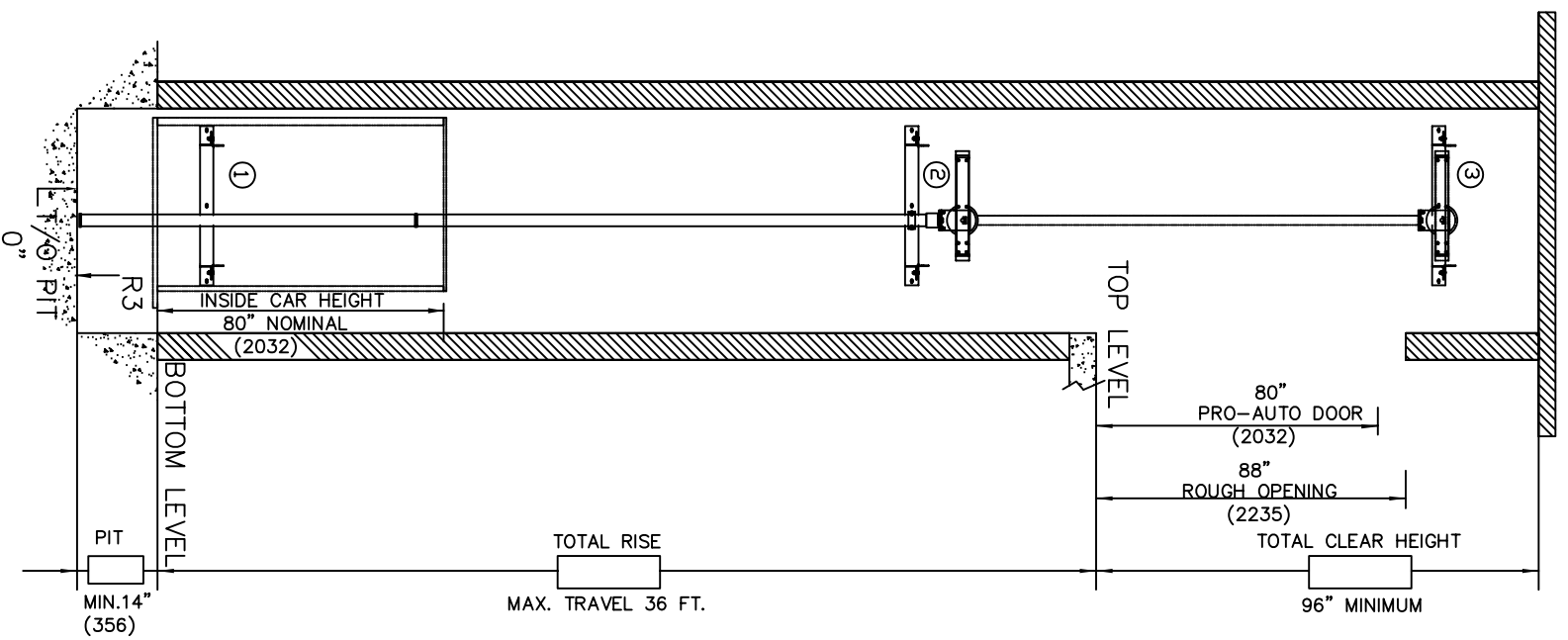

PLAN VIEW - PROLIFT VOYAGER Model 3560WS (Gated)

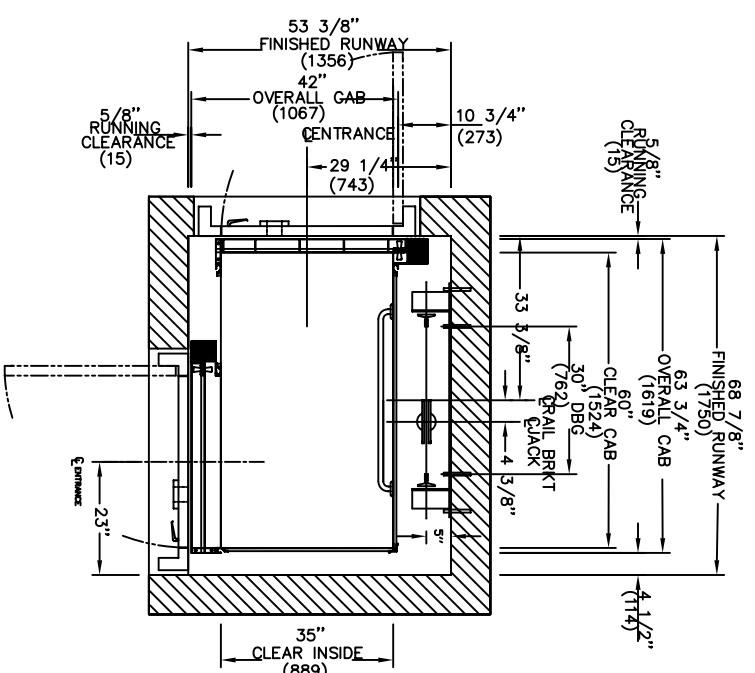

PLAN VIEW - PROLIFT VOYAGER Model 3560WS (Gated)

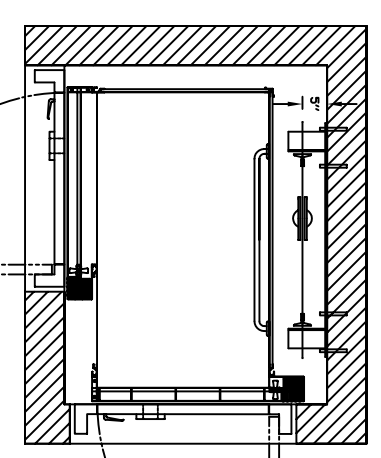

NOTE C: MIRRORED IMAGE OF TYPE 3 WITH SAME FINISHED HOISTWAY DIMENSIONS

| PIT / OVERHEAD REQUIREMENTS |          |              |                  |
|-----------------------------|----------|--------------|------------------|
| MAX. SPEED (ft./min)        | MIN. PIT | TOTAL TRAVEL | MINIMUM OVERHEAD |
| 30                          | 14" ***  | 96" (2439)   | 96" (2439)       |

\*\*\* NOTE: Additional pit equipment required when over 36" deep, consult your local dealer for details

| BRACKET                   | LOCATION | INTERVALS ABOVE BOTTOM BRACKET | AT TOP OF HOISTWAY CONSULT YOUR CONCORD REPRESENTATIVE FOR EXACT LOCATION |
|---------------------------|----------|--------------------------------|---|
| TOP RAIL BRACKET          | ③        | 48"                            | AT TOP OF HOISTWAY CONSULT YOUR CONCORD REPRESENTATIVE FOR EXACT LOCATION |
| INTERMEDIATE RAIL BRACKET | ②        |                                |   |
| BOTTOM RAIL BRACKET       | ①        | 24" ABOVE PIT FLOOR            |   |

| FLOOR No. | REAR / FRONT | FLOOR HEIGHT | TOTAL RISE |
|-----------|--------------|--------------|------------|
|           |              |              |            |

| RAIL FORCES |         | R3 NOTE:  |
|-------------|---------|---|
| * R1        | * R2    | PIT FLOOR TO SUPPORT LOAD OF: 822klbf * (INCLUDES IMPACT)               |
| 422klbf     | 180klbf | FOR TOTAL PULL-OUT FORCE ON RAIL BRACKET, R1 MUST BE DOUBLED TO 844klbf |

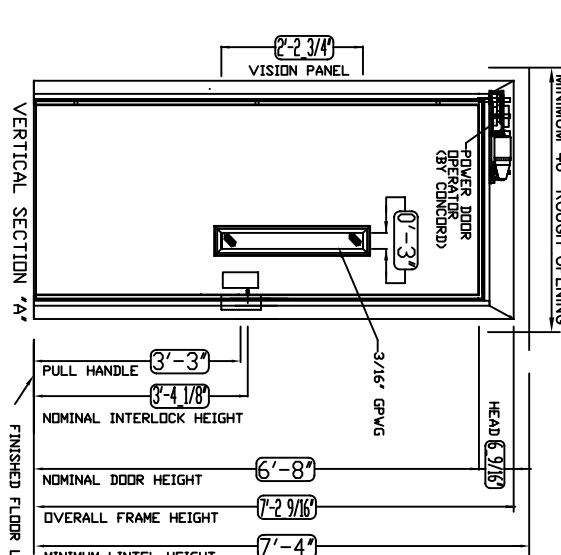
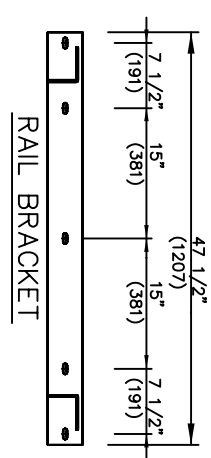
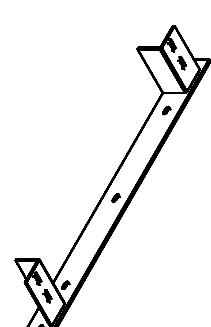

NOTE D: FLUSH PRO-AUTO DOOR SHOWN NONFLUSH RESIDENTIAL DOOR ACCEPTABLE

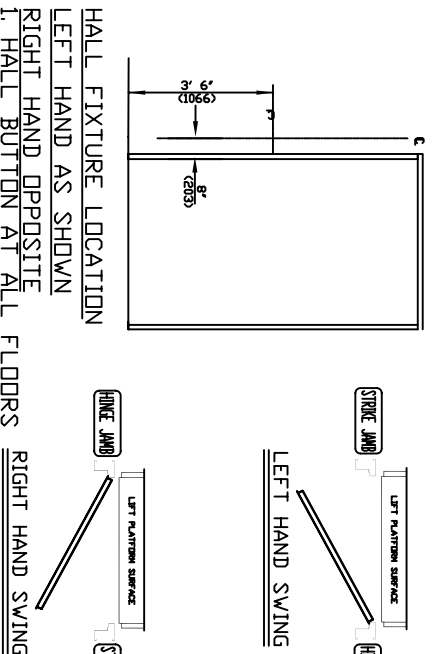

**PROVISIONS BY OTHERS**

**\*GENERAL HOISTWAY**- THE HOISTWAY MUST BE IN ACCORDANCE WITH "SAFETY CODE FOR ELEVATORS AND ESCALATORS" (ASME A17.1) AND ALL STATE AND LOCAL CODES.

**PLUMB HOISTWAY**- DUE TO CLOSE RUNNING CLEARANCES OWNER/AGENT MUST ENSURE THAT HOISTWAY AND PIT (WHERE PROVIDED) ARE LEVEL, PLUMB AND SQUARE AND ARE IN ACCORDANCE WITH THE DIMENSIONS ON THESE DRAWINGS.

**MINIMUM OVERHEAD CLEARANCE**- OWNER/AGENT MUST ENSURE MINIMUM OVERHEAD CLEARANCE IS IN COMPLIANCE WITH CODES.

**CONSTRUCTION SITE**- OWNER/AGENT TO PROVIDE ALL MASONRY, CARPENTRY AND DRYWALL WORK AS REQUIRED AND SHALL PATCH AND MAKE GOOD (INCLUDING FINISH PAINTING) ALL AREAS WHERE WALLS/FLOORS MAY REQUIRE TO BE CUT, DRILLED OR ALTERED IN ANY WAY TO PERMIT THE PROPER INSTALLATION OF THE LIFT.

**DIMENSIONS**  
CONTRACTOR/CUSTOMER TO VERIFY ALL DIMENSIONS AND REPORT ANY DISCREPANCIES TO OUR OFFICE IMMEDIATELY.

**\*STRUCTURAL**  
FLOOR/SUPPORT WALL LOADS- STRUCTURAL ENGINEER TO ASSURE THAT BUILDING AND SHAFT WILL SAFELY SUPPORT ALL LOADS IMPOSED BY THE LIFT EQUIPMENT. REFER TO THE TABLES ON THIS DRAWING FOR LOADS IMPOSED BY THE EQUIPMENT.

**WHERE DOORS ARE REQUIRED**- SUITABLE LINTELS MUST BE PROVIDED BY OWNER/AGENT. DOOR FRAMES ARE NOT DESIGNED TO SUPPORT OVERHEAD WALL LOADS.

**\*MACHINE ROOM**  
LOCATION / ACCESS- MACHINE ROOM LOCATED AT THE LOWEST LEVEL ADJACENT TO HOISTWAY, UNLESS SHOWN OTHERWISE ON THE LAYOUT DRAWINGS. FIELD ADJUSTMENT BY INSTALLER MAY BE NECESSARY TO MEET JOB SITE CONDITIONS OR REGULATIONS. ACCESS TO MACHINE ROOM TO BE THROUGH A SELF CLOSING LOCKABLE DOOR. SLEEVES FOR OIL & ELECTRIC LINES- FROM MACHINE ROOM TO RUNWAY AS REQUIRED. (POSITION PER INSTALLERS INSTRUCTIONS).

| TIME | DELAY FUSE SIZE | VOLTS             | PHASE           | AMPERAGE |
|------|-----------------|-------------------|-----------------|----------|
|      | 20AMPS/30AMPS   | 208V/230V/3PH/1PH | 10.6AMPS/17AMPS |          |
|      | 15 AMPS         | 115 V             | 1               |          |

**\*ELECTRICAL**  
POWER SUPPLY- (SEE SPECIFICATIONS) LOCKABLE FUSED DISCONNECT WITH AUXILIARY CONTACT TO BRAKE THE BATTERY FEED, OR CIRCUIT BREAKERS WITH A 3-POLE BREAKER FOR BATTERY FEED REQUIRED, IN COMPLIANCE WITH ELECTRICAL CODE, AS FOLLOWS:  
(LOCATED ON WALL ON LOCK JAMB SIDE OF MACHINE ROOM DOOR) PERMANENT POWER- BEFORE INSTALLATION CAN BEGIN, PERMANENT POWER MUST BE SUPPLIED.  
LIGHTING- OWNER/AGENT TO ENSURE AT LEAST 5 FTC OR 54 LUX AMBIENT LIGHTING OVER LIFT AREA.  
\*ENTRANCES  
FASCIA PANEL BELOW UPPER LEVEL ENTRANCE- WHERE REQUIRED, FASCIA PANEL MUST BE FASTENED TO A SOLID WALL AND BE PERPENDICULAR TO THE FLOOR AND WALLS. HOISTWAY FASCIA IS NOT SELF-SUPPORTING FOR LONG, CONTINUOUS RUNS VOID OF ENTRANCES. ADEQUATE SUPPORT FOR THE FASCIA MUST BE PROVIDED.  
ENTRANCE ASSEMBLIES- ENTRANCE ASSEMBLIES MUST BE ADJUSTED TO ALIGN WITH PLATFORM AND INTERLOCK EQUIPMENT. OTHERS TO ALLOW AN ADEQUATE ROUGH OPENING.  
RETURN WALLS- RETURN WALLS AT ENTRANCES MUST BE BUILT-IN BY OTHERS AFTER ENTRANCE ASSEMBLIES ARE IN PLACE. ENTRANCE ASSEMBLY MUST BE SECURELY FASTENED TO WALLS BY ELEVATOR CONTRACTOR.

**NOTE B**  
ALL INFORMATION IS SUBJECT TO CHANGE. PLEASE REFERENCE OUR ON-LINE DRAWINGS AT [www.concordlevator.com](http://www.concordlevator.com) FOR THE MOST RECENT UPDATES